

FREQUENT BUYER FLYER SPECIALS FOR MAY 2002

Visit Us On-Line
@ <http://www.envirospec.com>

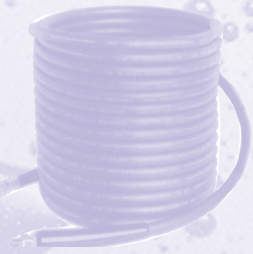

If it goes on a
Pressure Washer
we have it and...
we have it at the Best Price
in the Industry!

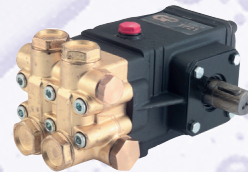
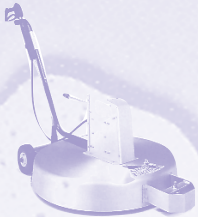

ENVIROPEC 2002



COBRA SUPER SKID

Gas Engine - Hot Water

The Industry's #1 Seller
Just Gas Up & Go to Work

Call for a complete listing of Standard features

Model	GPM	PSI	Eng/HP	Drive	Burner	Generator	WT	List	Sell
CO3530	3.5	3000	Honda 11	Belt	12VDC	NO	515	\$5,650.00	\$2,950.00
CO3930	3.9	3000	Honda 13	Belt	12VDC	NO	515	\$5,750.00	\$2,995.00
CO5230	5.2	3000	Vanguard 16	Belt	12VDC	NO	600	\$5,996.00	\$3,195.00
CO5230G	5.2	3000	Vanguard 16	Belt	120VAC	YES	600	\$6,695.00	\$3,622.00
CO4735	4.7	3500	Honda 20	Belt	12VDC	NO	610	\$6,550.00	\$3,556.00
CO4735G	4.7	3500	Honda 20	Belt	120VAC	YES	610	\$7,750.00	\$4,098.00
CO5635	5.6	3500	Honda 24	Belt	12VDC	NO	620	\$7,995.00	\$4,208.00
CO5635G	5.6	3500	Honda 24	Belt	120VAC	YES	620	\$8,695.00	\$4,624.00

RENEGADE MINI-SKID

Gas Engine - Hot Water

“Go Anywhere - Do Anything”
Just Gas Up & Go to Work

Call for a complete listing of Standard features



Model	GPM	PSI	Eng HP	Start	Drive	Burner	WT	List	Sell
R3020	3.0	2000	Robin 7.5	Recoil	Direct	12VDC	450	\$4,500.00	\$2,250.00
R3030	3.0	3000	Honda 9	Recoil	Direct	12VDC	550	\$4,625.00	\$2,314.00
R3530	3.5	3000	Honda 11	Recoil	Direct	12VDC	565	\$4,995.00	\$2,498.00
R3530E	3.5	3000	Honda 11	Electric	Direct	12VDC	565	\$5,300.00	\$2,650.00
R4035E	4.0	3500	Honda 13	Electric	Direct	12VDC	570	\$5,620.00	\$2,810.00



ELECTRIC “SUPER HOT”

Call for a complete listing of Standard features

Model	GPM	PSI	Motor HP	AMPS	Drive	Voltage	WT	List	Sell
SH2010	2.0	1000	1.5	15	Direct	120	310	\$2,490.00	\$1,245.00
SH1915	1.9	1500	2.0	20	Direct	120	310	\$2,560.00	\$1,280.00
SH2810	2.8	1000	2.0	20	Direct	120	310	\$2,560.00	\$1,280.00
SH2816	2.8	1600	3.0	18	Direct	230/1	315	\$2,960.00	\$1,480.00
SH3520	3.5	2000	5.0	22	Direct	230/1	335	\$3,800.00	\$1,900.00
SH4220A	4.2	2000	6.0	29	Belt	230/1	515	\$4,050.00	\$2,025.00
SH4220B	4.2	2000	6.0	19	Belt	230/3	510	\$4,120.00	\$2,060.00
SH4220C	4.2	2000	6.0	11	Belt	460/3	510	\$4,240.00	\$2,120.00
SH3530A	3.5	3000	7.5	36	Belt	230/1	520	\$4,240.00	\$2,120.00
SH3530B	3.5	3000	7.5	25	Belt	230/2	515	\$4,131.00	\$2,066.00
SH3530C	3.5	3000	7.5	13	Belt	460/3	515	\$4,360.00	\$2,180.00

35-155	Hour Meter	\$ 50.00
35-115	Time Delay Shutdown	\$ 350.00
35-117	Time Delay Shutdown (for 402007, 353007 models)	\$ 350.00
35-160	Float Tank	\$ 260.00
35-161	Float Tank (for 402007, 353007 models)	\$ 260.00
35-105	Stainless Steel Coil Wrap	\$ 155.00
35-106	Stainless Steel Coil Wrap (for 402007, 353007 models)	\$ 155.00

SURFACE SPINNER

CONCRETE, ROOF & DECK MACHINES

NEW FOR 2002
A Super Lightweight Floater



Steel Eagle Floaters
Super Lightweight
Max Flow 4.0 GPM

- #9874-012
12" 2 Nozzle Bar
\$209.95
- #9874-016
16" 2 Nozzle Bar
\$249.95

- Heavy Duty 12" & 16" floating aluminum deck
 - Super Lightweight
 - Heavy Duty Construction
 - 2-piece detachable handle
 - 3000 PSI maximum
 - 200 degree temperature
 - Heavy duty nylon brush
 - Balance spraybar
 - Powder coated handle
 - Heavy Duty Swivel
- Trigger and Nozzles sold separately



Non-adjustable with Optional Trigger

24" SERIES
with wheels

- #9874-102
24" 2 Nozzle Bar Non Adjustable
\$669.95
- #9874-103
24" 3 Nozzle Bar Non Adjustable
\$689.95
- #9874-100
24" 4 Nozzle Bar Non Adjustable
\$769.95



30" SERIES
with wheels

- #9874-107
30" 2 Nozzle Bar Non Adjustable
\$719.95
- #9874-108
30" 3 Nozzle Bar Non Adjustable
\$739.95
- #9874-109
30" 4 Nozzle Bar Non Adjustable
\$819.95
- #9874-104
30" 2 Nozzle Bar Adjustable
\$819.95
- #9874-105
30" 3 Nozzle Bar Adjustable
\$829.95
- #9874-106
30" 4 Nozzle Bar Adjustable
\$919.95

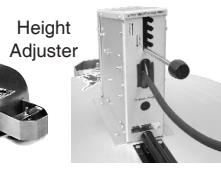

Optional Handles
"A" #9874A - Add \$45.00
"B" #9874B - \$55.00



STEEL EAGLE

Replacement Parts

- 24" Bar #9874-101 \$43.95 Per Bar
- 30" Bar #9874-112 \$46.15 Per Bar

Replacement Manifolds

- 2 Bar - Manifold Only #9874-221 \$39.95

3 Bar - Manifold Only

- #9874-222 \$44.95

4 Bar - Manifold Only

- #9874-224 \$139.95

Dublin Swivel (New)

- #9874-998 \$339.95

Dublin Swivel (Refurb)

- #9874-999 \$239.95

Refurbished are on a "when available" basis

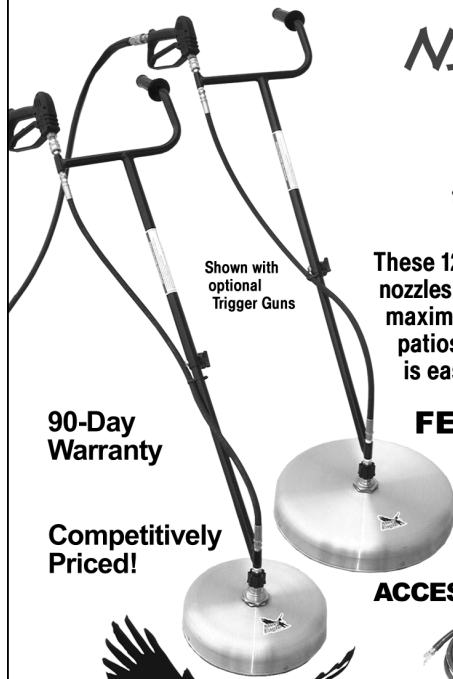

Shown with optional Trigger Guns

90-Day Warranty

Competitively Priced!

NEW! Smaller, lighter, economical!

"LITTLE FLOATER" SURFACE SPINNER

These 12" and 16" surface cleaners use force generated by your pressure washer to spin 2 spray nozzles at high speed, actually "floating" the spinner over the surface like a hover craft —which maximizes cleaning in small spaces and on uneven surfaces: sidewalks, driveways, pool decks, patios, roofs, etc. There are no wheels to hang up. And using a small, lightweight Little Floater is easy on the operator!

- FEATURES** • Heavy-duty 12" or 16" floating aluminum deck • Lightweight • Heavy-duty construction • 2-piece detachable handle for easy storage • 3000 PSI maximum • 200° F temperature • Heavy-duty nylon brush • Balanced spray bar • Powder-coat painted handle • Removable spray tips • Long-lasting, dependable, heavy-duty swivel

ACCESSORIES



Pressure-Washer Hose

Sandblasting Kit

Mini-Reel Hand Carry Kit

Reel Stack Kit

Bigger Spinners Available



1-800-447-3924 • www.steeleagle.com

Best Prices in the Industry!

STAINLESS STEEL PRESSURE GAUGES

Each gauge is bench tested for 20 minutes and has been calibrated to the most rigid industrial specifications to insure precise pressure adjustment. The gauges are glycerin filled to reduce the risk of damage due to "hi-spikes" or vibration.



STAINLESS CASE GAUGES

- #1799-103 3,000 PSI \$ 6.95
- #1799-105 6,000 PSI \$ 6.95

ALL STAINLESS GAUGE

- #1799-106 6,000 PSI \$12.95



Quick Connect PRESSURE GAUGE TESTER

Just One More Tool That Every Mobile Washer should have in their tool box!

- 6,000 PSI Glycerin Filled Gauge
- Brass Uni-Body Quick Connect
- Stainless Steel Sleeve
- #2299-999 \$9.95

SIPHON PUMPS

- Heavy Duty 7 GPM #8601-101 \$9.95
- Extreme Duty 7 GPM #8601-102 \$17.95

We highly recommend the **Extreme Duty Siphon Pump** for acids, caustics and very strong alkalis

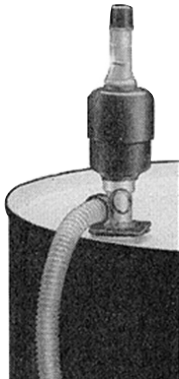

VEHICLE & HOUSE WASH

The Best in the Industry!



- #5055-101 10" New PolyFoam Block \$ 9.95
- #5055-104 14" Premium w/PolyFoam \$15.95
- #5055-105 14" Fine Finish Detail \$17.95
- #5055-102 18" New PolyFoam Block \$16.95
- #5055-103 24" New PolyFoam Block \$18.95

PREMIUM WIDE ANGLE

Holds Water Extremely Well

Super High Fill
Stays Wet Longer
New PolyFoam Block



- #5055-110 \$12.95

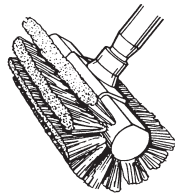

ShurSurface Brushes

It's hard to miss any area with this brush!

- #5056-102 Vehicles \$14.95
- #5056-103 Decks \$11.95

GUTTER & STACK BRUSH

Everyone should have this one! Contoured to fit hard to reach areas.



- #5056-101 \$22.95



GARDEN HOSE QUICK CONNECTOR

Solid Brass

Talk about convenient!

- #1025-101 Plug \$1.42
- #1025-102 Coupler \$2.00
- #1025-103 Complete Set \$3.30

Soap Nozzle - 1/4" MEG

Brass or Stainless Steel



Brass: \$1.99

- #NOB-2530 #NOB-2540 #NOB-2550
- #NOB-4030 #NOB-4040 #NOB-4050
- #NOB-6540

Stainless: \$2.99

- #NOS-1515 #NOS-2515 #NOS-4015
- #NOS-1520 #NOS-2520 #NOS-1525
- #NOS-2525 #NOS-2530 #NOS-2540
- #NOS-2550

Quick Connect Soap Nozzle



- #NOQB-6540 \$2.49

Note: Remember the First 2 Numbers are the Desired Pattern and the Second 2 Numbers indicate the Hole Size. The larger the hole the less restriction and the more the injector will draw.

Dirt Killer VAIRO-JET NOZZLE

Professional Duty by: Dirt Killer

Hi & Low Settings allow for both cleaning and chemical applications.

4300 Max PSI. & 195°



This is a real Heavy Duty Hi-Low Nozzle

- | Noz Size | | |
|--------------|--|---------|
| #974-030 3.0 | | \$26.95 |
| #974-040 4.0 | | \$26.95 |
| #974-045 4.5 | | \$26.95 |
| #974-055 5.5 | | \$26.95 |

Iron Horse Quality HI-LO NOZZLE

Variable Angle Spray - Hi & Low Settings allow for both cleaning and chemical applications.

4300 Max PSI. & 195°

Noz Size

- #2710-035 3.5
- #2710-040 4.0
- #2710-045 4.5
- #2710-050 5.0
- #2710-055 5.5
- #2710-060 6.0
- #2710-065 6.5
- #2710-070 7.0
- #2710-080 8.0



ANY SIZE \$9.95

HOW DO YOU READ A NOZZLE CHART?

Go across the top row Left to Right and find your PSI.

When you find your PSI go DOWN in that column until you find your GPM. If you do not find the EXACT GPM use the one which is slightly LOWER.

Now Follow the line Right to Left until you get to the nozzle column and that is the hole size that you will order.

EXAMPLE: Your machine is 5.6 at 3,500 PSI Go across the TOP until you find 3,500 PSI - NOW GO DOWN until you find "5.20" (not 5.7) - NOW GO LEFT until you get to the Nozzle Size Column - SEE - right there it says you need a 5.5 NOZZLE - WoW!

Please Order by Part Number

NOZZLE CHART

NOZZLE SIZE	100 PSI	1,000 PSI	1,500 PSI	2,000 PSI	2,500 PSI	3,000 PSI	3,500 PSI	4,000 PSI	5,000 PSI
2.0	.32	1.00	1.20	1.40	1.60	1.70	1.90	2.00	2.23
2.5	.40	1.25	1.53	1.77	1.98	2.17	2.34	2.50	2.80
3.0	.40	1.50	1.85	2.10	2.35	2.60	2.85	3.00	3.25
3.5	.45	1.70	2.17	2.45	2.73	3.05	3.32	3.50	3.90
4.0	.63	2.00	2.50	2.80	3.10	3.50	3.80	4.00	4.50
4.5	.74	2.20	2.80	3.00	3.60	3.90	4.30	4.50	5.03
5.0	.79	2.50	3.10	3.40	4.00	4.40	4.70	5.00	5.60
5.5	.87	2.80	3.40	3.80	4.40	4.80	5.20	5.50	6.20
6.0	.95	3.00	3.70	4.20	4.80	5.20	5.70	6.00	6.70
6.5	1.00	3.30	4.00	4.60	5.20	5.70	6.00	6.50	7.30
7.0	1.10	3.50	4.30	5.00	5.60	6.10	6.60	7.00	7.80
7.5	1.20	3.80	4.60	5.30	6.00	6.50	7.00	7.50	8.40
8.0	1.30	4.00	5.00	5.60	6.20	7.00	7.50	8.00	8.90
8.5	1.30	4.30	5.30	6.00	6.70	7.40	8.00	8.50	9.50
9.0	1.40	4.50	5.50	6.40	7.10	7.80	8.50	9.00	10.10
10	1.60	5.00	6.10	7.00	8.00	8.70	9.40	10.00	11.20

\$15.95



SUTTNER ST-1500 GUN
12 GPM - Up to 4,000 PSI
#2208-150

\$18.95



SUTTNER ST-2000 GUN
12 GPM - Up to 4,000 PSI
#2208-200

\$18.95



SUTTNER ST-601 GUN
12 GPM - Up to 4,000 PSI
#2208-601

\$9.95



Install on inlet side of trigger gun and then install the "QC on the other end of the whip

HOSE WHIP
Extends Quick Connect Life 10 Times
#2199-077

\$11.95



MAGNUM 4000 GUN
9 GPM - Up to 4,000 PSI
#2209-400

\$16.95



MAGNUM 4500 GUN
9 GPM - Up to 4,500 PSI
#2209-450

\$19.95



MAGNUM 5000 GUN
9 GPM - Up to 5,000 PSI
#2209-500

Starting Price \$2.99



As Low As \$2.59

HIGH PRESSURE NOZZLES
1/4" & 1/8" MEG - STAINLESS
"NOS- (degree and hole size)

\$17.95



PA-4000S GUN
10.5 GPM - To 4,100 PSI
#2299-403

\$17.95



AP-1000 GUN
12 GPM - To 4,500 PSI
#2299-100

\$15.95



HI-TECH 804 GUN
8 GPM - To 4,000 PSI
#2299-804

Starting Price \$3.25



As Low As \$2.85

HIGH PRESSURE NOZZLES
Quick Connect Style - STAINLESS
"NOQS- (degree and hole size)

\$27.95



HI-TECH 5700 GUN
8 GPM - To 5,700 PSI
#2210-055

\$19.95



HI-TECH 5000 GUN
11 GPM - To 5,000 PSI
#2299-500

\$17.95



J.E. ADAMS GUN
12 GPM - To 4,500 PSI
#2299-503

\$7.95

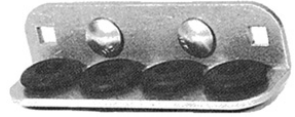

NOZZLE CADDY
Mounts on Any Pressure Washer
#7739-201

\$9.95



HI-TECH 100 GUN
Straight Thru - No Trigger
#2208-100

\$16.95



HI-TECH 606 GUN
Cushioned Grip - No Trigger
#2212-606

\$9.95



HI-TECH 702 GUN
7 GPM - To 2,500 PSI
#2299-702

\$11.95



SAFETY RELIEF VALVE
Handles up to 5,000 PSI
#1610-600

QUICK DISCONNECTS

Yes there is a huge difference in Quick Disconnects and the ones that we sell are - *the Best Money Can Buy!*

We use a 90 Durometer EPDM O-Ring and the material is rated to a 57 Rockwell Hardness

"SUPER HARD" PLUGS



PLATED STEEL PLUGS		
#QP4FB	1/4" FPT	\$0.69
#QP4MB	1/4" MPT	\$0.69
#QP8FB	3/8" FPT	\$0.79
#QP8MB	3/8" MPT	\$0.79

STAINLESS PLUGS - Incredible Value

#QP4FS	1/4" FPT	\$1.56
#QP4MS	1/4" MPT	\$1.53
#QP8FS	3/8" FPT	\$1.80
#QP8MS	3/8" MPT	\$1.76

TWIST FAST

Made in Germany

The Highest Quality Available!

TWIST FAST PLUGS

QP4FT	1/4" FPT	\$1.50
QP4MT	1/4" MPT	\$1.50
QP8FT	3/8" FPT	\$1.50
QP8MT	3/8" MPT	\$1.50



TWIST FAST COUPLERS

QS4FT	1/4" FPT	\$2.50
QS4MT	1/4" MPT	\$2.50
QS8FT	3/8" FPT	\$2.50
QS8MT	3/8" MPT	\$2.50

REPLACEMENT O'RINGS

for "QS-B" & "QS-S" Series Couplers
(sold in bags of 50 each)



Part #	Material	Size	Price
#QOR4B	Buna	1/4"	\$ 5.87
#QOR8B	Buna	3/8"	\$ 7.95
#QOR4E	EPDM	1/4"	\$ 8.25
#QOR8E	EPDM	3/8"	\$ 8.95
#QOR4V	Viton	1/4"	\$11.00
#QOR8V	Viton	3/8"	\$12.00

O'RING PICK - ya' gotta have it!



#7012-729 \$3.95

FOOT

CONTROLLER

Frees up hands while

Cleaning

Sewer Drains



In: 3/8" Out: 1/4" - 8 GPM Max - 3000 PSI Max

#5690	Valve Assy	\$45.70
#5700	Repair Kit	\$14.95

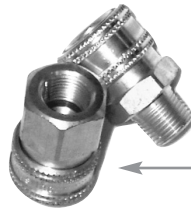

"HI-HEAT" COUPLERS

Examples of MALE PIPE (MPT)

Examples of FEMALE PIPE (FPT)

BRASS COUPLER

#QS4FB	1/4" FPT	\$1.79
#QS4MB	1/4" MPT	\$1.79
#QS8FB	3/8" FPT	\$1.99
#QS8MB	3/8" MPT	\$1.99

STAINLESS COUPLER - Incredible Value

#QS4FS	1/4" FPT	\$2.37
#QS4MS	1/4" MPT	\$2.49
#QS8FS	3/8" FPT	\$2.85
#QS8MS	3/8" MPT	\$2.84

What goes where?

Thanks for asking...

...because we are tired of being blamed for a lot of people ordering the wrong Plugs & Couplers!

First of all, you need to know the correct starting point. Please do not rely on the pressure washer manufacturer or typical distributor to be able to tell you the correct Quick Connect Set Up. They have both been doing it wrong for years.

Direction of Flow is commonly indicated by an arrow. Now let me ask you - which looks more like an arrow...

Item A



or

Item B



Direction of FLOW

If you picked "A" you are correct. So why, you ask, doesn't the manufacturer put them on right? Who knows! Maybe they were never Mobile Washers.

"IF" you have your System set up correctly with the plug indicating the direction of FLOW you can use the following as a guide.

Outlet of Coil/Pump = Plug

Inlet of Injector = Coupler

Outlet of Injector = Plug

Inlet of HP Hose = Coupler

Outlet of Hose = Plug

Inlet of Trigger = Coupler

Here is the only exception:

If you are using Quick Connect Nozzles you will need a Coupler on the outlet side of the lance

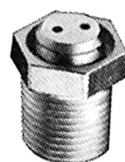

THERMAL RELIEF VALVE

Keeps Pump Head from overheating while in by-pass. Opens at 145 degrees.

#1410-111 \$9.95

FOR PRESSURIZED SYSTEMS ONLY

FOR WATER TANKS USE THE TERMINATOR

HI-PRESSURE SWIVELS

Swivels Under Pressure

Install a 3/8" swivel on the inlet side of the trigger gun to keep the hose from tangling and a 1/4" swivel on the outlet side of the gun for lance rotation.



Brass - 3800 PSI

#5510-101	1/4" FPTx MPT	\$11.95
#5510-102	3/8" FPTx MPT	\$11.95

Stainless Steel - 5600 PSI

#5599-201	1/4" FPTx MPT	\$15.95
#5599-202	3/8" FPTx MPT	\$15.95

Mosmatic - 3500 PSI

#5599-301	1/4" FPTx MPT	\$29.95
#5599-302	3/8" FPTx MPT	\$29.95

SWIVEL RIGHT ANGLE

360° Swivel Rotation
3/8" MPT Inlet/Outlet
4000 PSI max. - Brass
5000 PSI max. - S.S.



421018	Swivel-SS 3/8"	\$28.95
421019	Brass 1/2"	\$26.95
421020	Swivel-Brass 3/8"	\$21.95
075130	Repair Kit 3/8"	\$11.95
075128	1/2" Repair Kit	\$13.95

EXHAUST HOOD SWIVELS

Fixed Nozzle - Hi-Speed - Self Rotating



#6099-072	3"	\$174.00
#6099-073	6"	\$174.00
#6099-074	12"	\$174.00
#6009-075	16"	\$184.00
#6009-076	20"	\$213.00
#6009-077	24"	\$218.00

Nozzles Sold Separately

EXHAUST HOOD SWIVELS

Adjustable - Hi-Speed - Self Rotating

#6099-172	3"	\$179.00
#6099-173	6"	\$184.00
#6099-174	12"	\$189.00
#6099-175	16"	\$194.00
#6009-176	20"	\$221.00
#6009-177	24"	\$228.00



Nozzles Sold Separately

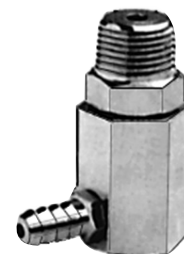

EASY START VALVE

Installs on the high pressure side of the pump to reduce back pressure during start-up. Not required on electric start engines - recoils only.

#1625-777 \$7.95
(less barb)

1-800-346-4876

Don't forget! We have more STUFF than anyone else in the Industry and at the Best Price!

ALL MODELS
\$44.95



K7-0 UNLOADER
FLOW TYPE - 2.1 to 2.9 GPM
#1510-070

K7.1 UNLOADER
FLOW TYPE - 2.9 to 4.2 GPM
#1510-071

K7.2 UNLOADER
FLOW TYPE - 4.2 to 6.6 GPM
#1510-072

K7-3 UNLOADER
FLOW TYPE - 6.6 to 10.8 GPM
#1510-073

K7 KIT
#1510-074 \$29.95

ALL MODELS
\$44.95



K5.0 UNLOADER
FLOW TYPE - 2.1 to 2.9 GPM
#1510-050

K5.1 UNLOADER
FLOW TYPE - 2.9 to 4.2 GPM
#1510-051

K5.2 UNLOADER
FLOW TYPE - 4.2 to 6.6 GPM
#1510-052

K5.3 UNLOADER
FLOW TYPE - 6.6 to 10.8 GPM
#1510-053

K5 REBUILD KIT
#1510-054 \$23.95

BY-PASS PLATE
#1510-555 \$3.95

\$22.95



HI-TECH 550
3500 PSI up to 8 GPM
#1599-550

\$38.95



"HM" UNLOADER
3000 PSI up to 10.8 GPM
#1510-121

\$24.95



HI-TECH 606 UNLOADER
3650 PSI up to 7.8 GPM
#1599-606

\$44.95



"VB10" UNLOADER
3650 PSI up to 8.0 GPM
#1599-010

\$44.95



2140 UNLOADER
4,100 PSI up to 21 GPM
#1510-128

\$22.95



HI-TECH 580
3600 PSI up to 8 GPM
#1599-580

\$69.95



SD5000 UNLOADER
Up to 5,000 PSI - 1 to 9 GPM
#SD5000

\$44.95



2121 UNLOADER
2200 PSI up to 21 GPM
#1510-127

\$26.95



PULSAR UNLOADER
4500 PSI up to 8 GPM
#1510-110

\$39.95



K12 UNLOADER
750-3500 PSI - 4--6 GPM
#K12

#520 \$17.95 #540 \$19.95
#550 \$22.95 #590 \$42.95



HI-TECH 520 UNLOADER
2,000 PSI to 8 GPM
#1599-520

\$24.95



607 UNLOADER
TO 8 GPM & 4500 PSI
#1599-101

\$295.00



STAINLESS STEEL UNLOADER
6200 PSI up to 21 GPM
#462656

\$99.00



VB350 UNLOADER
5600 PSI up to 6.6 GPM
#463680

HI-TECH 540 UNLOADER
2,500 PSI to 8 gpm
#1599-540

HI-TECH 550 UNLOADER
3,500 PSI to 8 GPM
#1599-550

HI-TECH 590 UNLOADER
3,500 PSI to 8 GPM
with Built-in Injector
with Built-in Easy Start Valve
with Built-in Thermal Protector
#1599-590

\$7.95



UNLOADER BLOCK
5,000 PSI RATED - BRASS
#1599-103

Remember - when using a straight lance you should consider installing a 45 degree elbow at the nozzle end in order to insure total surface contact.

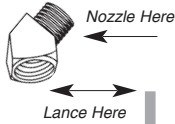

#140634 1/4" Elbow \$2.25

**DUAL LANCES
ZINC & STAINLESS STEEL**



Zinc

- #2310-105 36" General 1/8" Pipes \$31.95
- #2310-107 Repair Kit \$12.95
- #2310-106 72" General 1/8" Pipes \$39.95
- #2310-107 Repair Kit \$12.95
- #2308-040 40" w/Trigger 1/4" Pipes \$19.95
- #2310-110 Repair Kit (seals only) \$ 1.95

Stainless Steel

- #2310-109 36" Deluxe 1/4" Pipes \$28.95
- #2310-110 Repair Kit (seals only) \$ 1.95
- #2399-101 40" Deluxe 1/4" Pipes \$26.95
- #2399-105 Repair Kit \$11.95
- #2399-103 72" Deluxe 1/4" Pipes \$35.95
- #2310-110 Repair Kit (seals only) \$ 1.95

SPRAY FLEX WAND

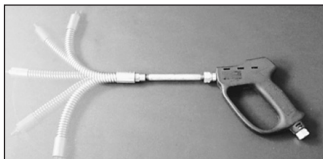

Bend it, Twist it, Turn it...
and it still holds it's shape under pressure

Awesome Tool



Handles up to
3,000 P.S.I.

#A0513 \$39.95

ALUMINUM LANCES

Heavy Duty, Super Light Weight Schedule 80. All with 1/4" male pipe thread ends. Can be used with the vented grip and side handle on this page. Great for extended use!

*Look For
Lance Accessories*

#3912	12"	\$ 6.50
#3924	24"	\$ 6.95
#3928	28"	\$ 6.95
#3932	32"	\$ 6.95
#3936	36"	\$ 6.95
#3948	48"	\$ 8.95
#3960	60"	\$11.95
#3972	72"	\$11.95
#3996	96"	\$12.95

LANCE ACCESSORIES

Make Up Your Own Lance!

FITS 1/4" PIPE



- #2311-101 Vented Grip \$5.95
- #7508-102 Adj. Side Handle \$4.95

These grips fit the aluminum lances above or any 1/4" water pipe and are easy to install.

**OVERSTOCK
PRICING ON
TELESCOPING
WANDS**

**Everyone Needs a
Telescoping Lance**



*Extends from
8' to 24'
to clean those
2 & 3 story
buildings*

Specifically Designed for EnviroSpec to allow you to draw chemical from a Downstream Injector.

This lance is equipped complete with an "easily replaced" trigger gun, lance, inner high pressure hose and a "quick coupler on the discharge side which accommodates a standard "quick connect nozzle"



- 18' 3,000 PSI #TW183 \$84.95
- 24' 3,000 PSI #TW243 \$89.95
- 24' 4,000 PSI #TW244 \$99.95
- Support Belt #TWBELT \$19.95

Industrial Grade
STAINLESS STEEL LANCES

with Molded Grips

All with 1/4" male pipe thread ends



Stainless Steel Lances

#2309-124	24"	\$ 6.95
#2309-128	28"	\$10.95
#2309-136	36"	\$ 9.95
#2309-148	48"	\$10.95
#2309-159	59"	\$16.95
#2309-179	79"	\$19.95

Super Heavy Duty
ZINC PLATED LANCES

with Molded Grips

All with 1/4" male pipe thread ends



Zinc Lances

#2308-112	12"	\$ 5.95
#2308-124	24"	\$ 5.95
#2308-136	36"	\$ 6.95
#2308-148	48"	\$ 7.95
#2308-160	60"	\$ 8.95
#2308-179	79"	\$10.95

INDUSTRIAL LANCES

Super Duty, Schedule 80, Black Iron Lances will last 10 times longer than the typical lance. All with 1/4" male pipe thread ends. Can be used with the vented grip and side handle on this page. These are the ones I used! John Allison

Built for the Long Haul!

#2307-112	12"	\$ 6.95
#2307-124	24"	\$ 8.95
#2307-136	36"	\$10.95
#2307-148	48"	\$10.95
#2307-160	60"	\$14.95
#2307-172	72"	\$16.95
#2307-184	84"	\$19.95
#2307-196	96"	\$21.95



FLEX LANCES

Flexes 180° and returns

Prevents bent lances & broken hoses

Industrial grade polyurethane flex section

Perfect for self-serve car wash bays

1/4" galvanized pipe end sections



2000 PSI - 200° F

Great for cleaning wheel wells, engines frames and hard to get to places.

Caution: one hand must be on lance at all times

#2312-018

18" Red - 1/4" MPT x 1/4" MPT
\$16.95



\$29.95

HIGH PRESSURE HOSE
3,000 PSI x 50' - BLACK
#B308-050



\$149.95

HOSE REEL
Holds 150' of 3/8" 1-Wire Hose
#5603 Includes Mounting Base



\$147.95

HOSE REEL
Holds 350' of 3/8" 1-Wire Hose
#5607



1/4" 2923-103 3/8" 2923-104

\$4.49

BALL VALVE
1/4" * 3/8" = 7,400 PSI RATING
1/2" = 5,000 PSI RATING



\$69.95

HIGH PRESSURE HOSE
3,000 PSI x 100' - BLACK
#B308-100



\$139.00

HOSE REEL
Holds 100' of 3/8" 1-Wire Hose
#5602 Includes Mounting Base



\$138.95

HOSE REEL
Holds 300' of 3/8" 1-Wire Hose
#5606



\$4.49

MINI BALL VALVE
1/4" #306544
3/8" #306546



\$48.95

HIGH PRESSURE HOSE
4,500 PSI x 50' - NON-MARKING
#G458-050 GRAY



\$119.00

HOSE REEL
Holds 50' of 3/8" 1-Wire Hose
#5601 Includes Mounting Base



\$129.95

HOSE REEL
Holds 150' of 3/8" 1-Wire Hose
#5605



\$19.95

3-WAY BALL VALVE
Solid Brass Construction
#2927-104



\$87.95

HIGH PRESSURE HOSE
4,500 PSI x 100' - NON-MARKING
#G458-100 GRAY



JUMPER HOSES
Equipment to Reel

3/8" x 4,500 PSI, 2 Wire



\$19.95

HI-TECH REEL SWIVEL
1/2" FPT OUT x 3/8" FPT IN
#6550-201

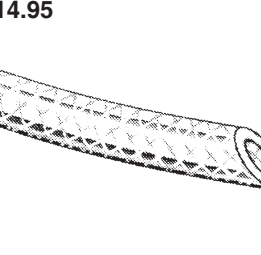

\$14.95

1/4" Poly-Braid Chem Line
100' Premium Line Tubing
#2012-100



\$47.95

HIGH PRESSURE HOSE
4,500 PSI X 50' - BLACK
#B458-050

1 Fixed End
1 Swivel End
No Strain Rieiefs

#2112-002	2' with ends	\$ 7.95
#2112-003	3' with ends	\$ 8.95
#2112-004	4' with ends	\$ 9.95
#2112-005	5' with ends	\$10.95
#2112-006	6' with ends	\$11.95
#2112-007	7' with ends	\$12.95
#2112-008	8' with ends	\$13.95
#2112-009	9' with ends	\$14.95
#2112-010	10' with ends	\$15.95



\$33.95

MOSMATIC REEL SWIVEL
"EASY SPIN" SERIES
#7777-500

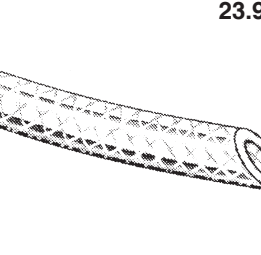

23.95

3/8" Poly-Braid Chem Line
100' Premium Line Tubing
#2012-575

**Popular Check Valve Kit
for General TS-2021
and many other General Pumps**

Standard Replacement
**Check Valves - Kit 1
#1310-101 \$17.95**



Super High Temperature
**Check Valves - Kit 1 HT
#1310-101HT \$22.95**

PACKING INSERTION KIT



Getting them out is one thing...
but getting them back in can
be a *nightmare!*
This kit makes that task
much, much easier.
#1310-524 \$10.95



\$16.95

**GENERAL
InterPump
KIT 8's**

*Old Style - Kit 8
(all brown)*
#1310-108

*New Style - Kit 8B
(3 brown 3 Black)*
#1310-108B

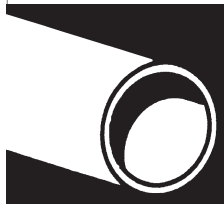

**CERAMIC
PISTONS**

**GENERAL
PUMP
TS-2021
and
INTERPUMP
WS-202
20MM**

**#1310-850
\$19.95**

**More...
POPULAR PUMP KITS
General / InterPump**

Kit 02	OIL SEALS 47 SERIES	\$ 8.95
Kit 03	CRANKSHAFT OIL SEALS	\$ 6.95
Kit 06	PISTON BOLT ASSEMBLY	\$15.95
Kit 07	HEAD RING KIT	\$ 4.95
Kit 09	INTERMEDIATE RINGS	\$19.95
Kit 10	PACKING RETAINER KIT	\$13.95
Kit 12	PACKINGS 22 MM	\$19.95
Kit 19	PACKINGS 20 MM	\$18.95
Kit 23	PISTON ROD OIL SEAL KIT	\$ 5.95
Kit 27	PACKING ASSEMBLY "T"	\$17.95

wow-weeeee
KIT 28 PACKINGS & BRASS \$17.95

Kit 29	PACKING ASSY 22 MM	\$19.95
Kit 88	PACK KIT EZ SERIES 15MM	\$19.95
Kit 109	T9281 PACKING KIT	\$44.95
Kit 123	TP SERIES VALVE KIT	\$19.95
Kit 130	EZ SERIES PACKING KIT	\$29.95

just remember - we've gottem all!

**Similar Savings on Kits for
CAT - A-R - Admiral - Giant**

*I know... these are
Incredible Prices*

**HI-TEMP KIT
Packing Assemblies**

Kit 1310-001 Includes:
1 Complete Set of
Super Hi-Temp Check Valves &
3 Complete Super Hi-Temp
Packing Assemblies including brass

#1310-001 \$89.95



1-800-346-4876

**BONUS PACK
*Super Buy!***

Complete Rebuild less Ceramics

1 Complete Set of Stock Check Valves &
3 Complete Stock
Packing Assemblies including brass

#1310-000 \$74.95

**Or - Why Not Just Go Ahead
and turn your Pump back into
the "Beast" it once was?**

Do it right with the 1310-001B Kit

which Includes:

3 Super Hi-Temp Check Valves and O'rings
3 Complete Sets of Super Hi-Temp Kit 28's
and 3 Ceramic Pistons

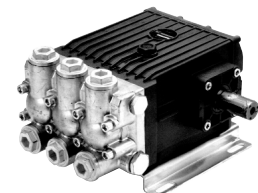

For
**TS-2021 & WS-202
Pumps
and others**
**#1310-001B
\$144.95**

\$44.95



**DIRT KILLER
TURBO NOZZLES**
3,200 PSI RATED

Nozzle	Size	Kit
#6006-101	3.0	#6006-111
#6006-102	3.5	#6006-112
#6006-103	4.5	#6006-113
#6006-104	5.5	#6006-114
#6006-105	7.0	#6006-115

\$71.95



**DIRT KILLER
TURBO NOZZLES**
4,700 PSI RATED

Nozzle	Size	Kit
#6006-201	3.5	#6006-211
#6006-202	4.5	#6006-212
#6006-203	5.5	#6006-213
#6006-204	7.0	#6006-214
#6006-205	8.0	#6006-215
#6006-206	10.0	#6006-216

\$34.95



**ROTOJET
TURBO NOZZLES**
3,600 PSI RATED

Nozzle	Size	Kit
#6119	3.0	#6219
#6120	3.5	#6220
#6121	4.0	#6221
#6122	4.5	#6222
#6123	5.0	#6223
#6124	5.5	#6224
#6125	6.0	#6225

\$54.95



**ROTOJET
TURBO NOZZLES**
3,600 PSI RATED

Nozzle	Size	Kit
#6126	4.0	#6226
#6127	4.5	#6227
#6128	5.0	#6228
#6129	5.5	#6229
#6130	6.0	#6230
#6131	7.0	#6231
#6132	8.0	#6232
#6133	12.0	#6233

#6010-101 2.1 - 2.9 GPM #6010-102 2.9 - 4.2 GPM



#6010-103 4.2 - 5.6 GPM #6010-104 KIT \$11.95

ROTO MAX TURBOS \$38.95
Tighter Pattern than those listed Above
Great for Gum Removal

#1925-101 with Check \$1.29



#1925-102 without Check \$0.99

PLASTIC CHECK VALVE
FITS 1/4" & 3/8" CHEMICAL LINE
With or Without Check Ball

\$17.95



TWIST TYPE

DUAL NOZZLE HOLDER
FOR DOWNSTREAM INJECTORS
#2427-101



SuperFlow INJECTOR
Up to 23% Draw Rate
The Best Injectors - Money Can Buy!
by Allison

Non-Adjustable Stainless Ball \$9.95
#5000 2-3 GPM
#5001 3-5 GPM
#5002 5-8 GPM

Non-Adjustable Ceramic Ball \$12.95
#5003 2-3 GPM
#5004 3-5 GPM
#5005 5-8 GPM

Adjustable with Stainless Ball \$14.95
#5006 2-3 GPM
#5007 3-5 GPM
#5008 5-8 GPM

Adjustable with Ceramic Ball \$17.95
#5009 2-3 GPM
#5010 3-5 GPM
#5011 5-8 GPM

\$36.95



TUROB SPLATTER SHIELD
Attaches to Lance
#6006-500

#1914-101 with Check \$2.75



#1914-102 without Check \$2.65

BRASS CHEM FILTERS
FITS 1/4" CHEMICAL LINE
80 MESH SCREEN

\$10.95



BALL TYPE

DUAL NOZZLE HOLDER
FOR DOWNSTREAM INJECTORS
#2410-101

#6014-101 Filter No Plug \$7.95



#6014-102 Filter with Plug \$8.95

HIGH PRESSURE FILTERS
for Turbo Nozzles
for Concrete Cleaners

\$3.99



THE BEST

PREMIUM CHEM FILTER
FITS 1/4" LINE
STAINLESS & BRASS

\$9.95



SHOWER TYPE

NOZZLE HOLDER
FOR DOWNSTREAM INJECTORS
#2412-444

#1899-701 2-3 GPM
#1899-702 3-5 GPM
#1899-703 5-8 GPM



\$49.95

STAINLESS INJECTOR
Stainless Steel Chemical Injector
for Bleach Users

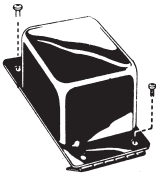

BURNER TRANSFORMERS & IGNITERS

- Beckett
- #4215-499 Igniter, 12V-S Complete \$94.95
 - #4215-500 Igniter, 12V-A Complete \$94.95
 - #4215-601 Transformer, 120V-A \$39.95
 - #4215-603 Transformer, 230V-A \$39.95
 - #4215-605 Transformer, 230V-S \$39.95
 - #4215-607 Transformer, 115V-S \$42.95

- Wayne
- #4212-012 12V, Back Hinge MSR \$97.95
 - #4212-115 115V, Side Hinge M-MSR \$29.95
 - #4212-117 115V, Back Hinge EH-EHA \$43.95
 - #4212-230 230V, Side Hinge, EH-EHA \$45.95

BECKETT BURNER MOTORS

- 120 Volt AFG
- #4215-755 \$64.95
- 120 Volt SM
- #4215-756 \$64.95
- 12 Volt ADC
- #4215-757 \$99.95
- 12 Volt SDC
- #4215-758 \$143.59

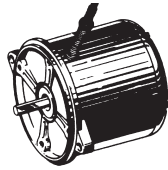

More Motors
PREVIOUS PAGE

BURNER TUNE-UP KITS



- #4215-900 Beckett \$14.95
- #4212-900 Wayne \$19.95

New for 2002

Beckett Fuel Pump with Built-in Solenoid Valve



#4215-274

Replaces Suntec A2VA-7116 Series
Awesome Price!
\$47.95
Includes Solenoid

Not the Cheap Stuff!

BURNER SWITCH
50 AMP @ 12 VOLT
On/Off Positioning



#4212-825 \$6.95

BURNER SOOT REMOVER
YOU HAVE NO CHOICE!
YOU MUST USE THIS!

Keeps Burners & Coils Running Clean!

- #4269-101 \$ 7.95 Per Quart
- #4269-102 \$72.95 Per Case (12)



BURNER NOZZLES

\$2.99 Each

- #4212-775 1.00 GPH
- #4212-776 1.25 GPH
- #4212-777 1.50 GPH
- #4212-778 1.75 GPH
- #4212-779 2.00 GPH
- #4212-780 2.25 GPH
- #4212-781 2.50 GPH
- #4212-782 2.75 GPH
- #4212-783 3.00 GPH

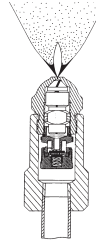

THERMOSTATS

IN-LINE FULLY ADJUSTABLE

Installs on the Outlet Side of the Coil
Temperature Range is 60°F to 230°F
Includes Lead Wire
#4560-101 \$32.95



PANEL MOUNT FULLY ADJUSTABLE

4000 PSI Max
302°F Max Temp
3-1/2" Immersion Bulb
60" Capillary Wire
Accuracy to 2.5%
16 AMP Rating - 250 Volt
Seal Nut & Coupling



- #4510-101 86 to 302 Degrees \$19.95

HI-LIMIT SAFETY SHUT DOWN

Shuts Down the Fuel Solenoid on the Burner should the Flow, Pressure or VAC Switch, or Thermostat Fail. When the water reaches 220 degrees at the sensing probe, the Hi-Limit terminates the current to the fuel solenoid.
A Must on Every System!



#4560-102 \$12.95

SUNTEC FUEL PUMPS

- #4215-275 A2VA7116 \$39.95
- #4215-276 A1VA7112 \$45.95
- #4215-277 A2VC7118 \$48.95
- #4215-278 A1YA7912 \$56.95
- #4215-279 A2YA7916 \$53.95



SUNTEC FUEL SOLENOIDS
with "Plug-in" Lead Wires

- #4241-100 110 Volt \$22.95
- #4215-101 220 Volt \$22.95
- #4215-901 12 Volt \$24.95



VAC SWITCHES

\$15.95



- #4012-101 For Gas Eng Systems
- #4012-102 For Elec Motor Systems

PRESSURE SWITCHES

250 Volts - 3650 PSI
190 degrees
15Amps

- 1/4 MPT, 580 PSI Switch
#4009-101 \$12.95

- 3/8 MPT, 580 PSI Switch
#4009-102 \$12.95



FLOW SWITCH
New for 2002

Did you know that 90% of all problems with Flow Switches are due to the reed itself?

No Reed with this Switch!
Handles up to 5,000 PSI
Handles up to 8 GPM
Rated for 5 AMP instead of the typical 1 AMP rating on other switches



BEST BUY!

#4008-008 \$27.95

STANDARD FLOW SWITCHES

\$19.95

- #4008-005 Vertical Mount (shown)

- #4008-006 Vertical or Horizontal Mount



PHOENIX INDUSTRIAL

Super Heavy Duty Flow Switch that can be mounted either in the Vertical or Horizontal Position

Works with Any Unloader!

#4010-101 \$64.95



FUEL PRESSURE GAUGE

Rated to 200 PSI

Most Fuel Pumps Run at 140-150 PSI

#1751-200 \$2.95



SHURflo PUMPS

with
Chemical
Resistant
Seals

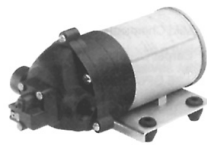

New for 2002

**Industrial Quality
TriggerJet Spray Gun**

always on sale...
TS-2021 / WS-202
\$290.00

5.6 GPM, 3,500 PSI, 1450 RPM

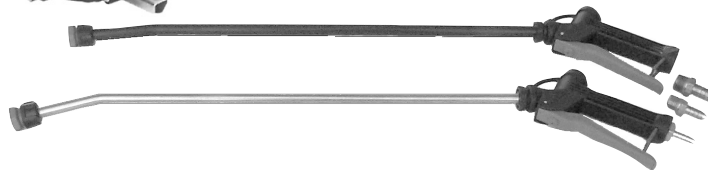
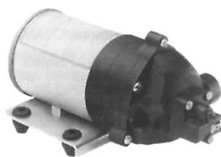

12 VOLT PUMPS

	GPM	PSI			
1231-150	Shurflo	1.2	60	Viton	\$ 93.95
1231-101	Shurflo	1.4	60	EPDM	\$ 66.95
1231-102	Shurflo	1.4	100	EPDM	\$ 69.95
1231-200	Shurflo	1.5	150	EPDM	\$112.95
1231-103	Shurflo	3.0	45	EPDM	\$ 85.95
1231-104	Shurflo	3.6	45	EPDM	\$139.95

115 VOLT PUMPS

	GPM	PSI			
1231-250	Shurflo	1.0	60	Viton	\$ 121.95
1231-201	Shurflo	1.4	60	EPDM	\$ 98.95
1231-203	Shurflo	1.5	150	EPDM	\$123.95
1231-301*	Shurflo	1.6	100	EPDM	\$122.95
1231-202	Shurflo	3.2	45	EPDM	\$121.95

**1231-301 has a Fused Cord*

TRIGGER GUNS

for above pumps

750 PSI Gun no Lance - Viton Seals

#2214-009 \$15.95

350 PSI Gun with Poly Lance
Viton Seals

#2214-110 \$14.95

350 PSI Gun with Stainless Lance
Viton Seals

#2214-111 \$17.95

Replacement Poly Nozzle

#2214-202 \$2.95

Replacement Brass Nozzle

#2214-103 \$9.95

1/2 Inlet - if you are using...

...1/4" Chem Line order Brass Barb #140361 \$1.73

...3/8" Chem Line order Brass Barb #140356 \$1.74

...1/2" Chem Line order Brass Barb #140362 \$2.75

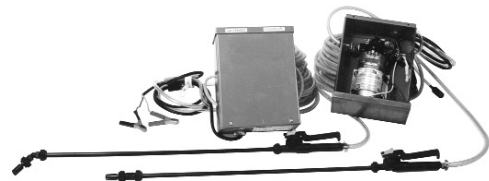
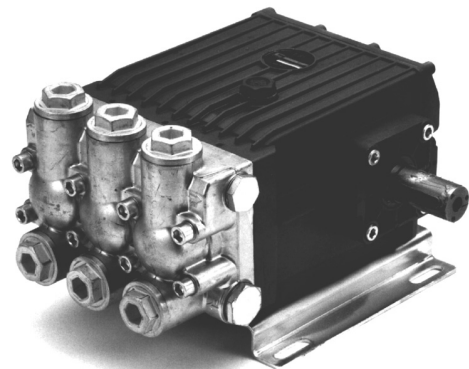

INDUSTRIAL

CHEMICAL SPRAYERS

Great for Roofs,
Exhaust Hoods & Decks

Complete with - Auto Shut-down
75' of Discharge Hose,
Weatherproof Cabinet
& Gun-Lance Assembly

115V @ 60 PSI @ 1.15 GPM
#290050 \$219.00

12V @ 60 PSI @ 1.02 GPM
#290054 \$199.00

Memory Coil Chemical Hose

Great for Chem Lines & Trigger Jet Guns
"No-Kinking"



Clear 1/4" Polyurethane
Strain Reliefs on Both Ends
Brass 1/4" MPT Ends

Great for SHURflo & Flojet Pumps
and Chemical Lines from Injector to Container

#KU30 30' \$32.95

#KU50 50' \$49.95

CHEMICAL TUBING

for injectors, SHURflo & Flojet Pumps



The Good Stuff From
KURIYAMA

Polybraided Reinforced

#2012-025	1/4" x 25'	\$ 7.95
#2012-050	1/4" x 50'	\$13.95
#2012-100	1/4" x 100'	\$22.95
#2012-300	1/4" x 300'	\$49.95
#2012-525	3/8" x 25'	\$ 8.95
#2012-550	3/8" x 50'	\$17.95
#2012-575	3/8" x 100'	\$33.95
#2012-600	3/8" x 300'	\$74.95

Check Out These Chemical Prices

ALL MAKE 55 GALLONS

Product	Description:	List	Sale
Prodigy	Nations #1 Truck Wash, Gloss Enhancers	\$ 79.95	\$54.95
Mr. Muscle	Super HD Truck Wash, Heavy Butyl Solvents	\$109.95	\$84.95
Citra Solv	Super HD Truck Wash, Heavy <i>Citrus</i> Solvents	\$ 84.95	\$59.95
Bond Breaker	Film Removing Truck Wash, Gloss Enhancers	\$119.95	\$94.95
Release	HD Truck/House Wash, with Butyl Solvents	\$ 74.95	\$54.95
Viper	HD Truck Wash, Heavy Butyl Solvents	\$ 74.95	\$54.95
Limonene	Nations #1 House Wash with <i>Citrus</i> Solvents	\$ 84.95	\$59.95
Premier	Heavy Duty House Wash, Low Butyl Solvents	\$ 78.95	\$54.95
Emulsifier Plus	Detergent Additive for Sodium Hypochlorite	\$ 79.95	\$49.95
Power Stroke	Non Caustic, Aggressive Concrete Cleaner	\$139.95	\$109.95
Hood Pro	Super HD, Non Caustic Exhaust Hood Cleaner	\$139.95	\$109.95
Restore 30 Lb.	Wood Restoration, makes old wood look NEW	\$ 78.95	\$55.95



All of our Products were
developed by

Mobile Washers

for

Mobile Washers

and believe me,
there is a

Huge

Difference!

No-one Competes with EnviroSpec Chemicals - absolutely No-one!

Need Help With Equipment? Call Our Friendly Technicians or Visit Our Webpage!

KOHLER ENGINES



RUNS QUIETER, LONGER

15 HP comes Standard with:

Engine Mounted Controls - Low Oil Shut-down
1" Key Shaft - 3.5"L Drive Shaft

15 H.P #44502 15 AMP \$699.00
Muffler #1278613 \$ 84.95

The Following Engines are

**SPECIAL KOHLER SPEC
FOR HIGH PRESSURE PUMPS**

18, 22 & 25 HORSEPOWER

Standard with:

Engine Mounted Controls - Low Oil Shut-down
Muffler sold separately

#K18 18 HP 1" Shaft 20 AMP \$ 950.00
#K22 22 HP 1" Shaft 20 AMP \$1,095.00
#K25 25 HP 1" Shaft 20 AMP \$1,175.00

**25 AMP ADD ON:
#K25A \$100.00**

THROTTLE CONTROL

36" THROTTLE CABLE



Stop working the engine & pump during by-pass. Speedmaster reduces engine speed when pump head pressure drops below 250 PSI. Reduces pump head heat build-up!

Easy Installation

#8822-101 \$ 44.95

HONDA ENGINES



#GC160	5.0	Recoil	\$236.00
#GX340	11.0	Recoil	\$646.00
#GX390	13.0	Recoil	\$697.00
#GX620	20.0	20 AMP E/Start	\$975.00
#GX670	24.0	20 AMP E/Start	\$1095.00

Includes Key Switch Package on 620 & 670
The 20 & 24 HP requires a muffler.

MUFFLERS FOR 20 HP:

#VHSM3	Low Mnt. Oil Filter Side	\$133.95
#VHRM3	Hi-Mnt. Oil Filter Side	\$143.95
#VHLM3	Hi-Mnt. Starter Side	\$143.95

MUFFLERS FOR 24 HP:

#VHRM4	Top Mount Oil Filter Side	\$143.95
#VHLM4	Top Mount Starter Side	\$143.95

BRIGGS & STRATTON OVERHEAD VALVE ENGINES

Electric Start & Low Oil Shutdown



	HP	Shaft	AMP	Exhaust	Tank	
#339451	16.0	1"	16A	Top Left	Yes	\$895.00
#339453	16.0	1"	20A	Low Left	No	\$895.00
#339452	16.0	1"	20A	Low Left	Yes	\$940.00
#339456	18.0	1"	20A	Low Left	No	\$975.00



Professional Series

A-R PUMP

5.5 @ 4,100 PSI

1450 RPM - 24MM Shaft

Special Purchase Program

List \$800.00

Direct Replacement for TS-2021

\$242.50

QUICK DRAIN OIL PLUG

for

Pumps, Gear Boxes, & Engines
Fits all engines with 3/4" plug.
Does not fit HONDA!

#4616-501 \$8.95



Special EnviroSpec Design ELECTRONIC TACH & HOUR METER

Installs in a heartbeat - A Must for Every Engine

For single and twin cyl. engines. Simply wrap
the red wire around a plug wire
& ground the black wire!

Works on ALL 2 Cyl Gas PW Engines
Including KOHLER



#4616-502 \$36.95

EXTEND-A-WAND

3-Section Units

3,000 PSI with 1/4" Hose

#ETW1234	4.6' - 12'	\$171.55
#ETW1834	6.6' - 18'	\$188.75
#ETW2434	8.6' - 24'	\$207.75

New For

2002

3-Section Units

4,000 PSI with 1/4" Hose

#ETW1244	4.6' - 12'	\$188.75
#ETW1844	6.6' - 18'	\$207.75
#ETW2444	8.6' - 24'	\$229.75

SPECIAL NOTE: If your intention is to use the or any Telescoping Wand along with a Downstream Chemical Injector you will need to purchase a wand with a 3/8" hose.

3-Section Units

3,000 PSI with 3/8" Hose

#ETW1238	4.6' - 12'	\$176.75
#ETW1838	6.6' - 18'	\$198.75
#ETW2438	8.6' - 24'	\$215.75

1-800-346-4876

Tough Products, Gentle Prices.

EXTEND YOUR PRODUCTIVITY WITH... EXTEND-A-WAND



WHAT MAKES IT THE BEST?



PIN-LOK adjustment design enables the operator to extend and retract the wand fast...up to 10 X FASTER...saving you time and money...no screw connectors to hassle with.



The universal gun mount and Suttner's ST2605 gun along with a unique mounting system makes field repairs quick and easy with just two allen screws.

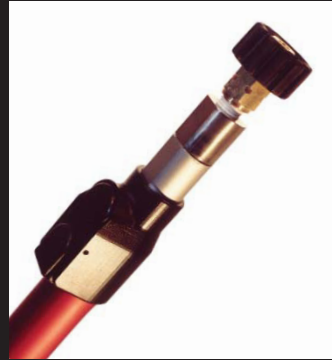

Flat sided aluminum tubing extensions keep the cleaning nozzle inline with the gun...saving frustrating alignment time. The servicable end fitting allows for quick maintenance to the hose.

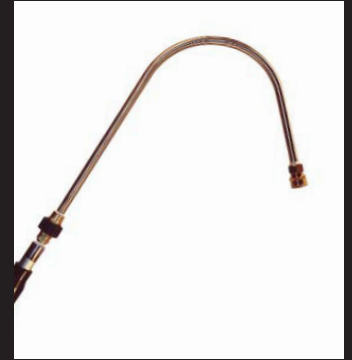

Extendawand offers quick attach cleaning accessories for every job from industrial to residential. Available are Rotating Nozzles, Brushes, Gutter Cleaning, Window Washing, Roof Washing.

MORE FEATURES FOR GREATER PROFITS:

- Thick wall extruded aluminum construction
- Extensions do not ride on one another eliminating binding up
- Reinforced impact resistant injected molded parts throughout
- Thermal comfort grip, no gloves required even at 210 F

SIX MODELS... ONE FOR EVERY APPLICATION.

TWO SECTION WANDS			THREE SECTION WANDS		
EX36	EX459	EX612	EX412	EX618	EX824
3'6"-6'	4'6"-9'	6'6"-12'	4'6"-12'	6'6"-18'	8'6"-24'

ENVIROSPEC 2002

751 MLK Highway
Homerville, GA
31634



Presort Standard
U S POSTAGE
PAID
Permit No. 10
Norman Park, GA
31771

1-800-346-4876

Helping
others live
the
**AMERICAN
DREAM**
every day!



High Performance Pumps
and Accessories

**A Family
Company**

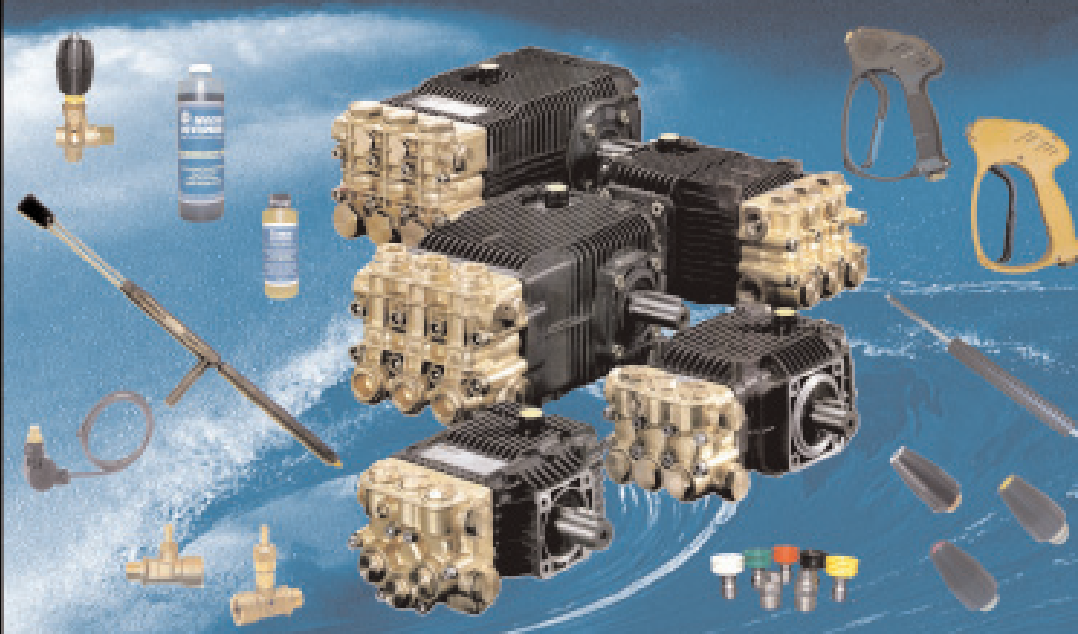

**Dependable • Durability • High Quality
Performance • Value**

Find your local AR North America
Service Dealer at:
www.ARNorthAmerica.com



Working to Keep
YOU
Connected

AR North America, Inc.
Industrial Division
711 - 5th Street SW • New Brighton, MN 55112
800-893-4235 Fax: 800-331-2762